

Actuator

MD51



Features

- ◆ MD51 features its compact design, powerful load capacity (up to 3500N), which is suitable for various applications that require limited installation space and high force
- ◆ Main applications : furniture and homecare
- ◆ Input voltage : 24V DC
- ◆ Max. load : 3500N (push) / 2000N (pull)
- ◆ Max. current : 3.8A @ 24V DC
- ◆ Max. speed : 11.4 mm/sec @ no load
- ◆ Stroke : 100 ~ 600 mm (other stroke available)
- ◆ Duty cycle : 10% or 2 min continuous operation in 20 min.
- ◆ IP Protection level : IP66
- ◆ Color : Black
- ◆ Certified : EN60601-1-2 / IEC 61000-4-2 / IEC6100-4-8 / IEC61000-4-3
- ◆ Noise Level : \leq 65dB (Normal Version) / \leq 62dB (Quick Version)
- ◆ Preset limit switches

Options

- ◆ Push only

Compatibility

1. Control box

CB3T-HP、CB4M-HP (High power version)

2. Handset

HA、HC、HD、HF、HJ、HK、HM、H2N、H3N、HT、HR

3. Accessory

None

Performance Data

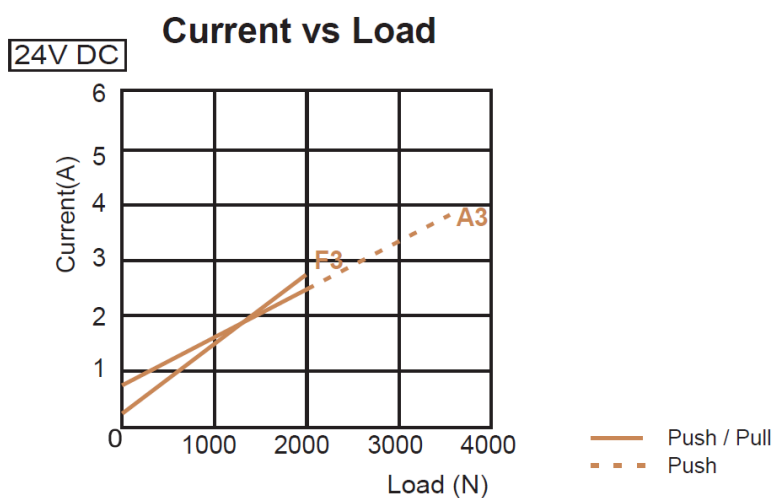
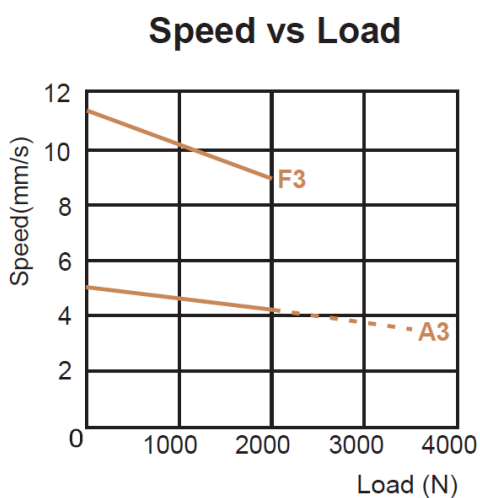

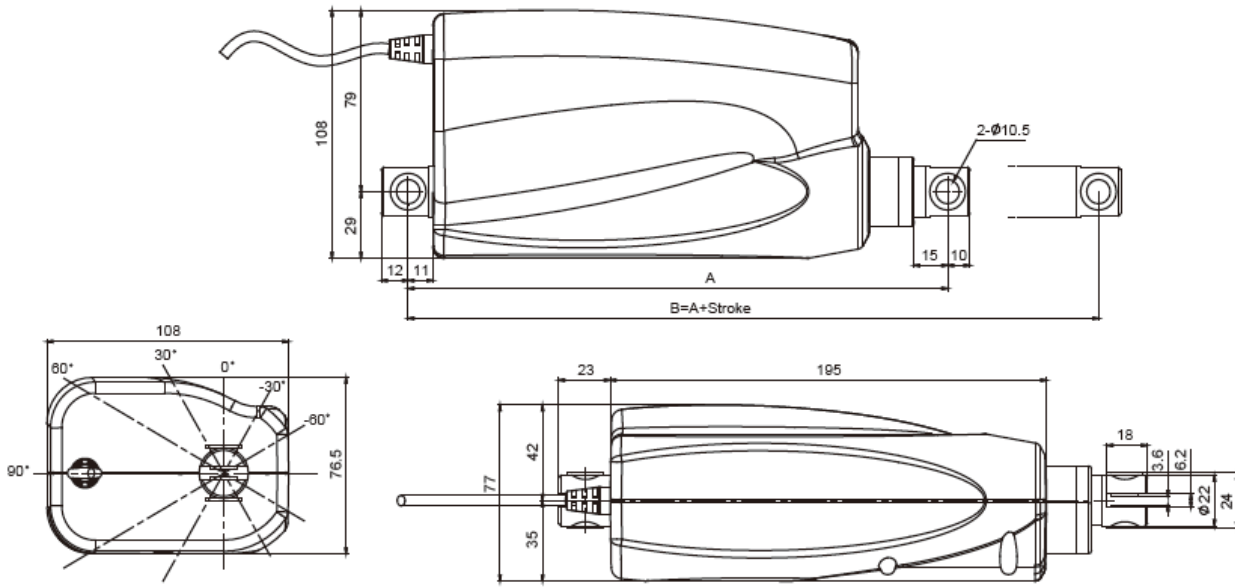

Model No.	Push Max. (N)	Pull Max. (N)	Speed (mm/s)		Current (A) @ 24V DC	
			No load	Full load	No load	Full load
MD51-XX-A3-XXX.XXX	3500	2000	5	3.8	0.8	3.8
MD51-XX-F3-XXX.XXX	2000	2000	11.4	9	0.3	2.7

Dimensions



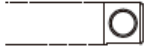

Unit: mm

Front Connector

-  C 1 x Metal + Nylon bushing
ø 10
-  C 2 x Metal
ø 12
-  C 3 x Metal + Brass bushing
ø 10

Rear Connector

-  C x 1 Metal + Nylon bushing
ø 10
-  C x 2 Metal
ø 12
-  C x 3 Metal + Brass bushing
ø 10

Unit : mm

Stroke (S)	100	150	200	250	300	350	400	450	500	550	600
Retracted Length (A)	241	291	341	391	441	510	560	610	660	710	760
Extended Length (B)	341	441	541	641	741	860	960	1,060	1,160	1,260	1,360
Max. Load (kg)	400	350	350	350	350	200	200	150	150	150	150

If the stroke is \leq 300mm , Retracted length (Dimension A) is S+141 mm.
 If the stroke is $>$ 300mm , Retracted length (Dimension A) is S+160 mm.

Ordering Key

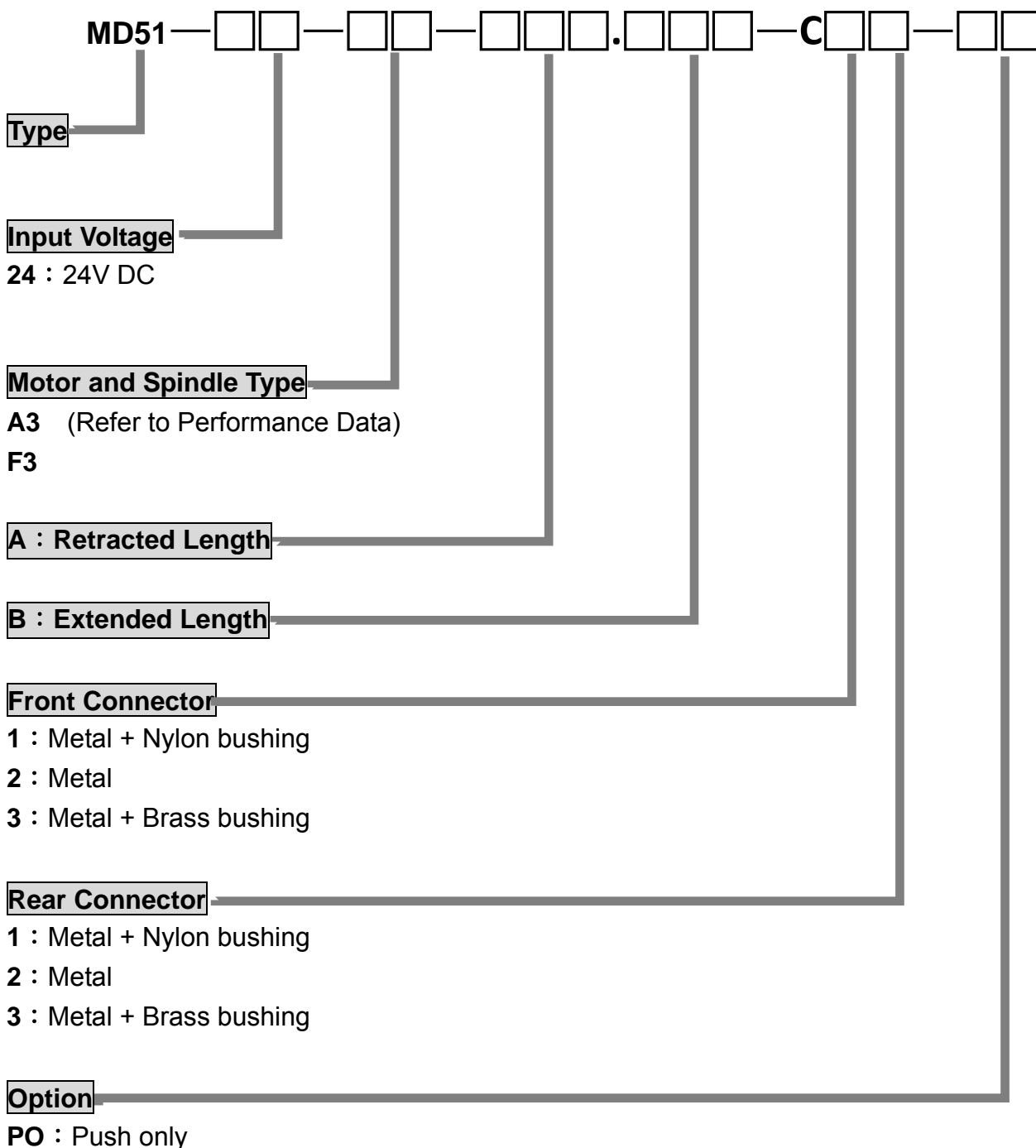

Terms of Use

The user is responsible for determining the suitability of MOTECK products for specific applications. Due to continuous development in order to improve its products, MOTECK products are subject to frequent modifications and changes without prior notice. MOTECK reserves the right to discontinue the sale of any products displayed on its website or listed in its catalogue or other written materials drawn up by MOTECK.

MO-FAM-2-T-001-140505A